

STONEFIRE GAS FIRE PIT TABLE



DORA BROWN STONEFIRE FIRE PIT TABLE



GREY STONEFIRE FIRE PIT TABLE

COZY, VERSATILE DESIGN

The Stonefire Fire Pit Table features a compact design that's versatile for a variety of spaces. This easy-to-move fire table has everything you need in both a table and a fire pit. It includes a matching burner cover for use as a functional table. Available in 2 colors: Dora Brown and Grey. 16" Crystal Fire® Plus Burner is UL Listed for safety and quality.

FEATURES:

- Stonefire composite top – Dora Brown or Grey
- Dora Brown or Grey powder-coated aluminum frame with Brown or Grey mesh base
- 16" Stainless Steel burner – 55,000 BTUs (LP)
- Matching composite burner cover included
- Access door conceals standard 20 lb. propane tank in base
- Optional glass wind guard and protective cover
- UL Listed

STONEFIRE GAS FIRE PIT TABLE

PRODUCT INFORMATION:

ITEM	PRICE
Dora Brown Stonefire	\$997.00
Grey Stonefire	\$997.00

OPTIONAL ACCESSORIES:

ITEM	PRICE
Protective Cover	\$62.00
Glass Wind Guard	\$285.00

DIMENSIONS:

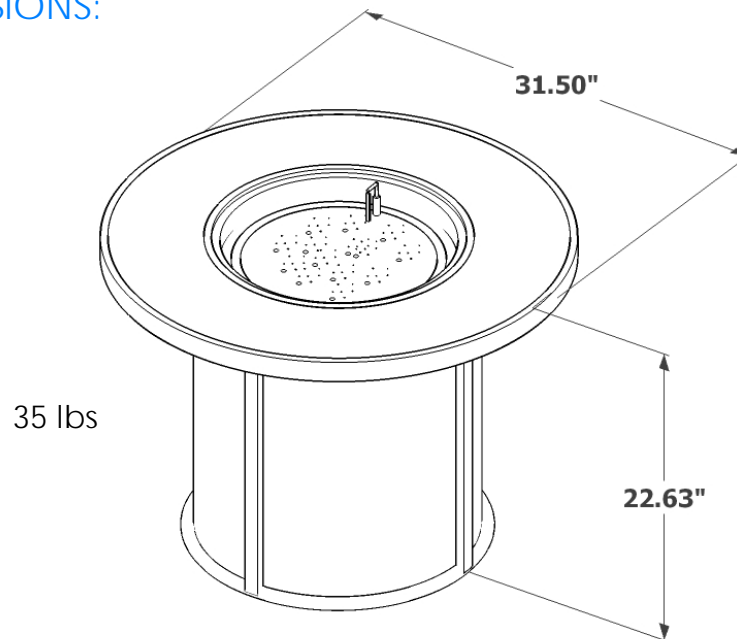

AUTHORIZED DISTRIBUTOR:



Brooklyn Park
763-488-1300

Burnsville
952-894-4400

Oakdale
651-770-1391