

BROOKS FIRE PIT TABLE



EASY-TO-CARE-FOR-MODERN STYLE

The composite deck top and base brings a modern, warm look to your outdoor room. Admire the easy-to-care-for design as you relax or entertain guests. The unique elevated 12x24" Crystal Fire® Plus Burner is UL Listed for safety and will dazzle guests.

FEATURES:

- Easy-to-maintain Taupe composite decking top and base
- Graphite Grey powder-coated aluminum framing
- Elevated 12 x 24" Stainless Steel Burner - 55,000 BTUs (LP)
- Grey glass burner cover included
- Access door conceals standard 20 lb. propane tank in base
- Optional glass wind guard and protective cover
- UL Listed
- Glass Guard is highly recommended for use on products with composite material

BROOKS FIRE PIT TABLE

PRODUCT INFORMATION:

ITEM	PRICE
Brooks Fire Pit Table	\$1,424.00

OPTIONAL ACCESSORIES:

ITEM	PRICE
Glass Wind Guard	\$219.00
Protective Cover	\$75.00

DIMENSIONS:

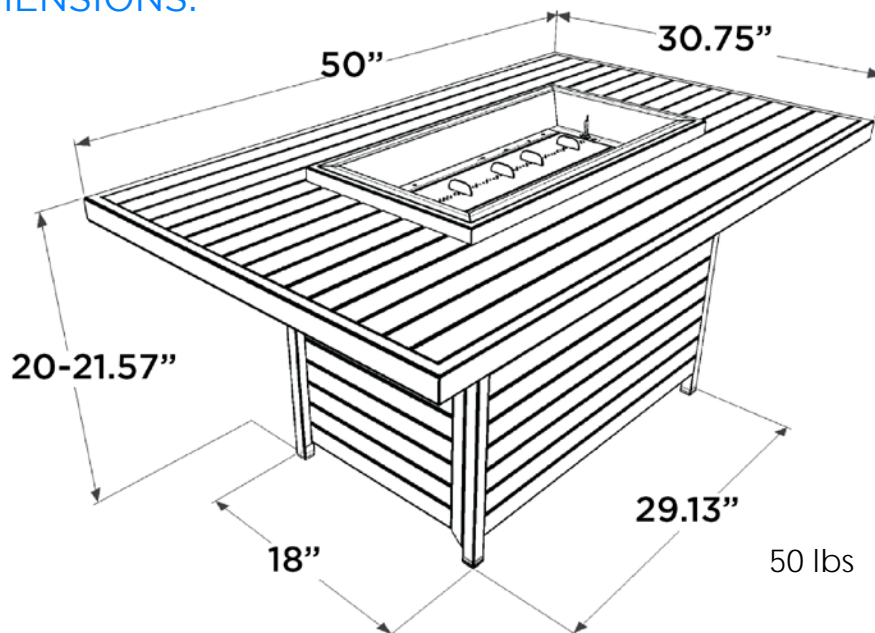

AUTHORIZED DISTRIBUTOR:



Brooklyn Park
763-488-1300

Burnsville
952-894-4400

Oakdale
651-770-1391